



SA200



General Description

The SA200 is a new high performance temperature controller specifically designed for applications where panel space is critical yet maximum control performance is required!

Features

- ☆ 1/32 DIN size with dual display
- ☆ Close vertical and horizontal mounting
- ☆ Self-tuning and autotuning
- ☆ Loop break alarm and temperature alarms
- ☆ Digital communications with both MODBUS and RKC protocols

Designed for close vertical or horizontal mounting



The SA200 allows you to mount several units close together to make effective use of control board or panel space.

A maximum of six units can be closely mounted.

Digital communications MODBUS/ANSI protocol (Optional)

The SA200 offers an optional RS-485 communications interface for networking to computers, PLCs and SCADA software. MODBUS or ANSI protocol can be selected. Up to 32 units, including host computer, can be multi-dropped on one RS-485 communication line. When the communication feature is selected, the external contact input is not available.

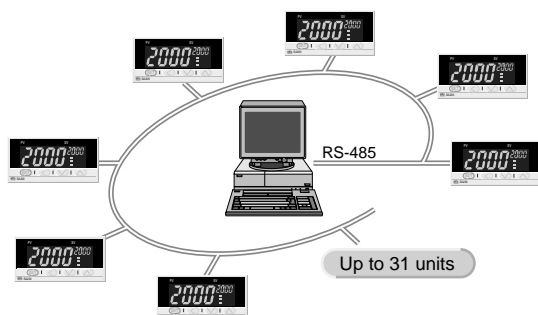

RKC self-tuning Advanced algorithm for optimum control

RKC self-tuning offers the most advanced algorithm for precise temperature control. Self-tuning is initiated at start-up and when process parameters or conditions change. At these times, new PID parameters are calculated for the best control performance. With the unique RKC self-tuning, the controller evaluates whether PID parameters should be maintained or replaced, selecting the best setting for the controlled process. If it is determined that the existing PID parameters can achieve the best control for the process, the present PID parameters will be retained and the new PID parameters will be canceled. Self-tuning can be turned on/off in parameter setting mode. Self-tuning is not available with heat/cool control.

In addition to self-tuning, the controller also has autotuning (AT) so that either function can be selected for optimum process control.

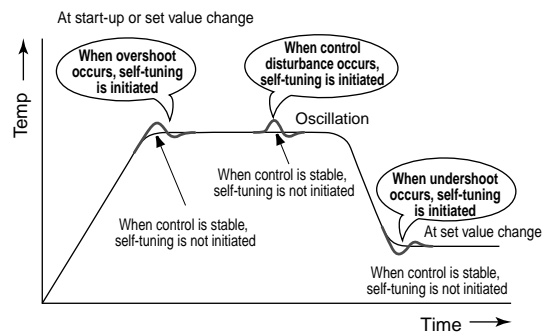

Waterproof and dustproof protection (Optional)

The waterproof and dustproof feature protects the panel-mounted instrument in severe environments or wash-down conditions and conforms to IP66(NEMA4) standards.



Features

Control loop break alarm and temperature alarms (Optional)

The control loop break alarm (LBA) monitors and protects an entire temperature control system. The LBA detects heater breaks, thermocouple or RTD failures, short circuits, or the failure of an operating device such as a mechanical or solid state relay.

When the PID computed value reaches 100% and the temperature does not respond in a set time, the loop break alarm is activated. Conversely, when the PID value reaches 0% and the temperature does not respond accordingly, the loop break alarm is turned on.

In addition to the control loop break alarm, deviation (high, low, high-low), process (high, low), set value (high, low) and band alarms can be selected.

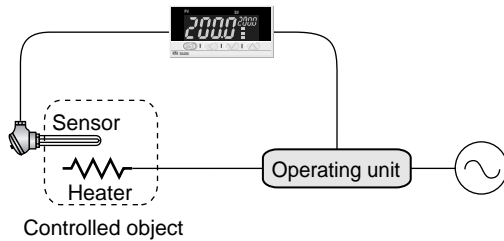

Heat/cool control (Optional)

The heat/cool PID controller has heat and cool outputs for use where process-generated heat exists. The controller allows the input of overlap or deadband settings which can contribute to energy savings.

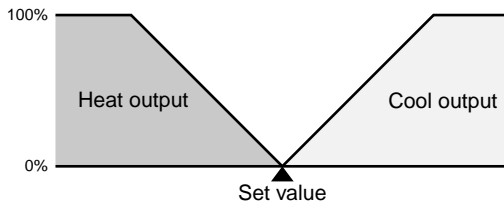

Digital contact input for external switching (Optional)

An optional digital contact input is available for RUN/STOP and SV1/SV2 switching. (RUN/STOP switching can also be completed at the front key panel.) This function can be used with the output from a timer, PLC, etc. When the communication feature is selected, the external contact input is not available.

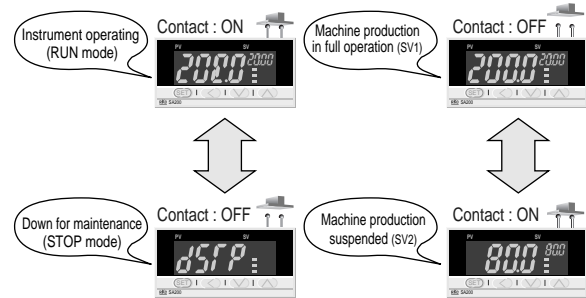

Easy maintenance

The internal assembly of the SA200 can be removed from the front of a control board. It is easy to inspect, maintain or replace the instrument because it does not require access from the back of the panel.





Specifications

Input

Input

- a) Thermocouple : K, J, E, T, R, S, B, N (JIS/IEC), PLII (NBS)
W5Re/W26Re(ASTM), U, L (DIN)
- Input impedance : Approx. 1M Ω
 - Influence of external resistance : Approx. 0.2 μ V/ Ω
 - Input break action : Up-scale
- b) RTD : Pt100(JIS/IEC), JPt100(JIS)
- Influence of lead resistance : Approx. 0.01[%/ Ω] of reading
• Maximum 10 Ω per wire
 - Input break action : Up-scale
 - Input short action : Down-scale
- c) DC voltage input : 0 to 5V DC, 1 to 5V DC, 0 to 10V DC
- d) DC current input : 0 to 20mA DC, 4 to 20mA DC
- For DC current input, connect a 250 Ω resistor to the input terminals.
 - Refer to the Input and Range and Input Code Table for details.
 - Input break action : Down-scale
 - Both heat/cool control outputs are OFF for heat/cool PID action.
 - Reading is around zero for 0 to 5V DC input, 0 to 10V DC input and 0 to 20mA DC input.

Sampling time
0.5 sec.

PV bias

- span to +span (Within -1999 to 9999)

Performance

Measuring accuracy

- a) Thermocouple
- $\pm(0.3\%$ of reading + 1 digit) or $\pm 2^{\circ}\text{C}$ (4°F) whichever is larger
 - Accuracy is not guaranteed between 0 and 399 $^{\circ}\text{C}$ (0 and 799 $^{\circ}\text{F}$) for type R, S and B.
 - Accuracy is not guaranteed less than -100.0 $^{\circ}\text{C}$ (-158.0 $^{\circ}\text{F}$) for type T and U.
- b) RTD
- $\pm(0.3\%$ of reading + 1 digit) or $\pm 0.8^{\circ}\text{C}$ (1.6 $^{\circ}\text{F}$) whichever is larger
- c) DC voltage and DC current
- $\pm(0.3\%$ of span + 1 digit)

Insulation resistance

More than 20M Ω (500V DC) between measured terminals and ground
More than 20M Ω (500V DC) between power terminals and ground

Dielectric strength

1000V AC for one minute between measured terminals and ground
1500V AC for one minute between power terminals and ground

Control

Control method

- a) PID control (with autotuning and self-tuning function)
- Available for reverse and direct action. (Specify when ordering.)
 - ON/OFF, P, PI and PD control are also selectable.
 - ON/OFF action differential gap : 2 $^{\circ}\text{C}$ (4°F) (Temperature input)
0.2% (Voltage, current input)
- b) Heat/cool PID control (with autotuning function)
- Air cooling and water cooling type are available. (Specify when ordering.)

Major setting range

Set value : Same as input range.
Heat side proportional band : 1 to span or 0.1 to span
(ON/OFF action when P=0)
Cool side proportional band : 0 to 1000% of heat side proportional band
Integral time : 0 to 3600sec. (PD action when I=0)
Derivative time : 0 to 3600sec. (PI action when D=0)
Anti-Reset Windup (ARW) : 1 to 100% of heat side proportional band
(Integral action is OFF when ARW=0)
Proportional cycle time : 1 to 100 sec.
Deadband/Overlap : -span to +span (Within -1999 to 9999)

Outputs

Output

- Can be set for control or alarm functions.
- Alarm output can be set for energized/de-energized action.
- Alarm output can be set for AND/OR logic calculation.

Number of outputs : 2 points

Output type

- Relay contact output : 250V AC 2A (resistive load), Form A contact
- Voltage pulse output : 0/12V DC (Load resistance : more than 600 Ω)
- Measurement terminals and output terminal are not isolated.

Alarms (Up to 2 points)

(Optional)

Alarm type

Deviation High, Deviation Low, Deviation High-Low, Deviation Band
Process High, Process Low, Set value High, Set value Low
Loop break alarm(LBA)

Setting range

- a) Deviation alarm : -span to +span (Within -1999 to 9999)
b) Process alarm : Same as set value (SV).
c) Set value alarm : Same as set value (SV).
d) Loop break alarm : 0.0 to 200.0 min.

Differential gap

2 $^{\circ}\text{C}$ (4°F) or 2.0 $^{\circ}\text{C}$ (4°F) (Temperature input), 0.2% (Voltage, current input)

Contact input

(Optional)

Number of inputs : 2 points

Contact input type

- a) RUN/STOP switching (OPEN : STOP, CLOSE : RUN)
b) STEP function (OPEN : SV1, CLOSE : SV2)

Input rating

Non-voltage contact input. (OPEN : 500k Ω or more, CLOSE : 10 Ω or less)

Communications

(Optional)

- a) Communication method : Based on RS-485 (two-wire)
b) Communication speed : 2400, 4800, 9600, 19200 BPS
c) Protocol : ANSI X3.28(1976) 2.5 A4
MODBUS
- d) Bit format
- Start bit : 1
 - Data bit : 7 or 8 •For MODBUS 8 bit only
 - Parity bit : Without, Odd or Even
 - Stop bit : 1 or 2
- e) Communication code : ASCII(JIS) 7-bit code
f) Maximum connection : 31 (Address can be set from 0 to 99.)

Waterproof and dustproof

(Optional)

Dustproof and waterproof protection : IP66

- Dustproof and waterproof protection are effective only from the front direction when installed on a panel.
- Dustproof and waterproof are not effective when controllers are closely mounted.

General specifications

Supply voltage

- a) 85 to 264V AC (Including supply voltage variation)
[Rating : 100 to 240V AC] (50/60Hz common)
b) 21.6 to 26.4V AC (Including supply voltage variation)
[Rating : 24V AC] (50/60Hz common)
c) 21.6 to 26.4V DC (Ripple rate 10% p-p or less)
[Rating : 24V DC]

Power consumption

Less than 4VA (at 100V AC), 7VA (at 240V AC) for standard AC type
Less than 4VA for 24V AC type
Less than 100mA for 24V DC type

Effect by power failure

A power failure of 20 ms or less will not affect the control action.
If power failure of more than 20 ms occurs, controller will restart.

Operating environments : 0 to 50 $^{\circ}\text{C}$ [32 to 122 $^{\circ}\text{F}$] , 45 to 85% RH

Memory backup : Backed up by non-volatile memory.

Net weight : Approx. 110g

External Dimensions (W x H x D) : 48 x 24 x 100mm (1/32 DIN)

Operating environment

Free from corrosive and flammable gas and dust.

Other conditions

Free from external noise, vibration, shock and exposure to direct sunlight.

Compliance with standards

- CE marked
- UL recognized
- CSA certified
- C-Tick marked



Model and Suffix Code

Alarm code table

A	Deviation High	B	Deviation Low	C	Deviation High - Low	D	Deviation Band
E	Deviation High with hold	F	Deviation Low with hold	G	Deviation High - Low with hold	H	Process High
J	Process Low	K	Process High with hold	L	Process Low with hold	R	Loop break alarm *1
V	Set value High	W	Set value Low				

*1: Loop break alarm is not available with heat/cool PID control type.

Output allocation code table

Code	Specifications		
	Control methods	Output 1	Output 2
0 3	PID control + Alarm 1	Control output	Alarm 1 output (De-energized)
0 4	PID control + Alarm 1, 2	Control output	AND logic output of Alarm 1 and Alarm 2 (Energized)
0 5	PID control + Alarm 1, 2	Control output	OR logic output of Alarm 1 and Alarm 2 (De-energized)
0 6	PID control + Alarm 1, 2	Control output	AND logic output of Alarm 1 and Alarm 2 (De-energized)
0 7	PID control + Alarm 1, 2 or only Alarm 1 *1	Control output	No output
0 8	PID control + Alarm 1, 2	*1 Control output	Only Alarm 1 output (Energized)
0 9	Alarm 1 + Alarm 2	*2 Alarm 1 output (Energized)	Alarm 2 output (Energized)
1 0	Alarm 1 + Alarm 2	*2 Alarm 1 output (Energized)	Alarm 2 output (De-energized)
1 1	Alarm 1 + Alarm 2	*2 Alarm 1 output (De-energized)	Alarm 2 output (De-energized)

*1: The alarm monitor can only be confirmed by front LCD display or serial communication.

*2: Specify control action F to use both outputs as alarms.

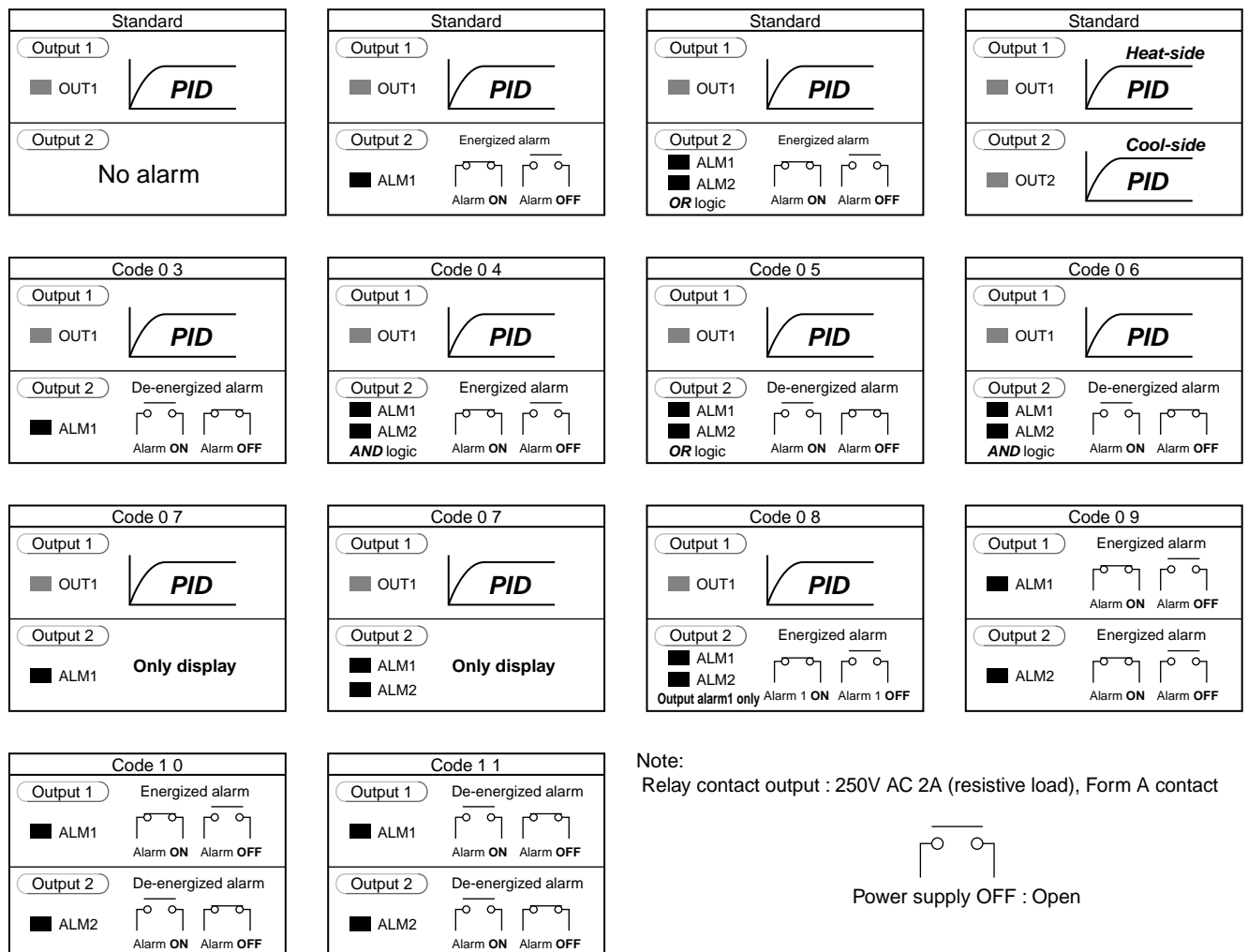

Note:

Relay contact output : 250V AC 2A (resistive load), Form A contact

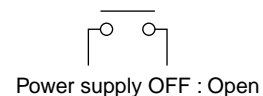

Accessory

Name	Model code
Shunt resistor for DC current input	KD100-55
Terminal cover	KSA200-56A

External Dimensions and Rear Terminals

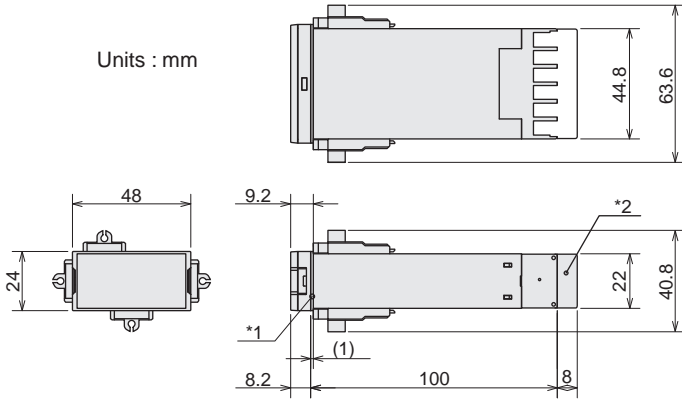

*1 For waterproof and dustproof models, a rubber packing is added.

*2 Terminal cover is optional.

For mounting of the SA200, panel thickness must be between 1-10 mm. When mounting multiple SA200s close together, the panel strength should be checked to ensure proper support.

Two mounting brackets will be furnished for installation of the instrument at either the top and bottom or sides.

Close vertically and horizontally mounted instruments cannot be combined in one installation.

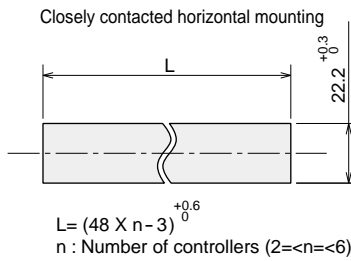
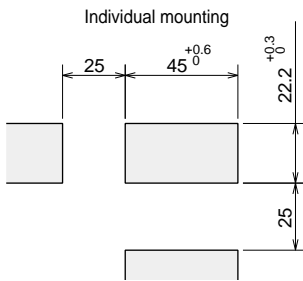

Closely contacted vertical mounting

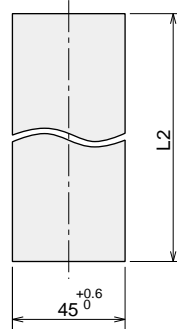

$L = (24 \times n - 1.8)$
n : Number of controllers (2 ≤ n ≤ 6)

Warning

If the SA200s have waterproof/dustproof options, protection may be compromised by close mounting. Close vertical mounting is not available when a shunt resistor for current input is used.

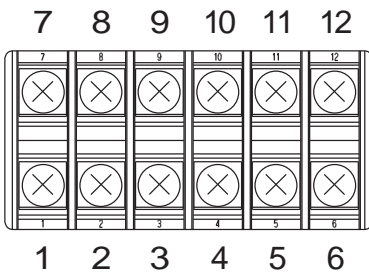

No.	1	2	3	4	5	6
Contents	100 to 240V AC	N	Voltage pulse	Voltage pulse	Relay contact	Relay contact
	24V AC/DC		Relay contact	Relay contact		
	Power supply		Output 1		Output 2	

No.	7	8	9	10	11	12
Contents	①			SG	T/R(A)	T/R(B)
	②			RS-485		
	③			DI1		
	③			DI2		
	Measured input			Communications / Contact inputs		

Note :

- Terminal assembly for unspecified functions will not be furnished.
- For terminal connection, use lug that is 5.8 mm wide or less.

*A 250Ω resistor is externally connected at the input terminals.